

connecting needs with capabilities

VeriFast™ MicroView 1.0 User Manual

MicroView 5-Port Dual Device
MicroView 10-Port Dual Device
MicroView 5-Port Single Device

Ver. 1.17 – March 2026

FDP-VFA-MCV-UM-1.17-0326

Contact Information

Head Office:

CenterLine (Windsor) Limited

415 Morton Drive

Windsor ON N9J 3T8

Canada

CAN. 519.734.8464

Toll Free: 800.820.6977

E-mail: info@cntrline.com

For additional contact information, visit our website at www.cntrline.com

Disclaimer

This manual is provided for informational purposes only. Those responsible for the application and use of this product are responsible for ensuring that the product meets all applicable laws, regulation codes, and standards. CenterLine (Windsor) Limited does not, by the publication of this document, intend to urge action that is not in compliance with applicable laws, and this document may not be construed as doing so. CenterLine (Windsor) Limited has made every effort to ensure the accuracy and completeness of this document; however, because ongoing efforts are made to continually improve the capabilities of our products, we cannot guarantee the accuracy of the contents of this document. We disclaim liability for errors, omissions, or future changes herein.

In no event will CenterLine (Windsor) Limited be responsible or liable to any party for any personal injury, property or other damages of any nature whatsoever, whether special, direct, indirect, incidental, consequential or compensatory, directly or indirectly resulting from the publication, use of, or reliance on this document, and also from the use of the equipment described herein.

In issuing and making this document available, CenterLine (Windsor) Limited is not undertaking to render professional or other services for or on behalf of any person or entity. Nor is CenterLine (Windsor) Limited undertaking to perform any duty owed by any person or entity to someone else. Anyone using this document should rely on his or her own independent judgment or, as appropriate, seek the advice of a competent professional in determining the exercise of reasonable care in any given circumstances.

The illustrations, explanations, charts, and layout examples shown in this publication are intended solely for purposes of example. Since there are many variables and requirements associated with any particular installation, CenterLine (Windsor) Limited does not assume responsibility of liability (including intellectual property liability) for actual use based upon the information given in this publication.

Reproduction of the contents of this copyrighted publication, in whole or part, without written permission of CenterLine (Windsor) Limited, is prohibited.

© Copyright 2026, CenterLine (Windsor) Ltd. All rights reserve

Table of Contents

Contact Information	2
Preface	5
Who Should Use This Manual	5
Purpose of This Manual.....	5
Conventions Used in This Manual.....	5
Terminology and Symbols Used Throughout This Manual.....	6
Safety Information	7
Important Safety Information	7
Handling the VeriFast™ MicroView	7
Potential Hazards Related to VeriFast™ MicroView	7
Equipment and Process Overview	9
Intended Use of Equipment	9
Technical Specifications	9
VeriFast™ MicroView Configuration.....	10
5-port Dual Device Controller and Connection Cables	10
10-port Dual Device Controller and Connection Cables	11
5-port Single Device Controller and Connection Cables.....	12
Description of I/O.....	13
Digital Inputs	13
Digital Outputs	13
Analog Inputs	14
Dimensions of VeriFast™ MicroView Controller.....	15
Part Ordering Information	15
Installation Guidelines	16
Important Safety Information	16
Mounting the MicroView Unit.....	16
Installation Precaution for Field Block Applications	16
Wiring the Ports of VeriFast™ MicroView	17
5-port Dual Device Port Configuration	17
10-port Dual Device Port Configuration	18
5-port Single Device Port Configuration.....	20
Pinout Diagram for 4, 5, and 8 Pin Connectors	21
Setup Scaling	22
Changing the Default Passwords	23
Re-Calibrating the Signal Conditioner (for VeriFast™ LVDT only. This procedure is rarely necessary) .	25
Re-Calibrating the Signal Conditioner for Distinct Applications.....	26

Software Overview	27
Screens Navigation Chart.....	27
Landing Screen / Screen Saver.....	27
Run Screen.....	28
Password Screen	28
User Password.....	29
Maintenance Password.....	29
Teach Screen	30
Step Thru Teach Screen	31
Maintenance Settings Screen.....	33
Tolerance Screen	34
Scaling Screen	35
I/O Test Screen	36
USB Storage Screen	37
System Settings Screen (accessible from More button).....	38
Teaching the MicroView	40
Teaching Positions for VeriFast™ IA, LVDT, or Laser	40
Teaching Positions for LPT	41
Teaching Positions for Generic Device	41
Setting the Tolerance Windows for Fasteners.....	41
Maintenance / Troubleshooting	42
Important Safety Information	42
Servicing the Lithium Battery.....	42
Resetting Passwords and Settings to Factory Defaults.....	44
Troubleshooting Quick Guide	45
Decommissioning	46
Preparing for Storage	46
Index.....	47

Preface

Who Should Use This Manual

Any person installing, using, or maintaining a VeriFast™ MicroView 1.0 controller should use this manual.

Purpose of This Manual

This manual describes the function, installation, and necessary operating instructions for the proper use of the standard VeriFast™ MicroView controller. For assistance with any other customized products or non-standard applications, additional support is available from CenterLine. Please refer to the inside front cover of this manual for CenterLine contact information.



To prevent potentially serious or fatal injury, this manual must be read and understood in its entirety prior to installation, operation, or maintenance of any VeriFast™ MicroView controller.

IMPORTANT

While every effort has been made to ensure that the product descriptions, procedures, and installation requirements included in this publication are accurate at the time of printing, CenterLine reserves the right to make product changes that might not be reflected in this document.

Should you require additional information, please contact CenterLine, its agents, or distributors for assistance.

Conventions Used in This Manual

This manual uses the following notations:

- Bulleted lists – such as this one – provide information, not procedural steps.
- Numbered lists provide sequential steps to follow or hierarchical information.
- When we refer you to a different section of this manual or to other documentation, the *section*, *chapter*, and *publication title* appear in *italics*.

Terminology and Symbols Used Throughout This Manual

Throughout this manual, all the safety related notes have been identified by the following terms:



This symbol relates information about practices or situations that can lead to personal injury or death, property damage, or economic loss.

Attention statements help you to:

- Identify a hazard.
- Avoid a hazard.
- Recognize the consequences.

IMPORTANT

This symbol relates information that is critical for a successful application and understanding of the product.



This symbol indicates that a serious hazard can occur due to an explosion.



This symbol indicates that serious hazards can occur due to pinch points.



This symbol indicates that you should read and understand the User Manual and all other applicable instructions before operating the equipment.



This symbol indicates that the equipment must be disconnected from all sources of power and put in the lockout state.



This symbol indicates that eye protection must be worn as a protection against dust, flying objects and particles.



This symbol indicates that appropriate safety shoes must be worn in order to avoid injuries from exposure to working environment.



This symbol indicates that the equipment must be kept dry, protected from excessive humidity and rain.

Safety Information

Important Safety Information

The VeriFast™ MicroView 1.0 controller is used in conjunction with welding equipment and machinery. Therefore, as a supplement to the safety information offered in this manual for the VeriFast™ MicroView controller, all the safety considerations that pertain to the equipment used in conjunction with this device still apply and must be followed thoroughly.

Furthermore, all the existing plant safety regulations and other safety instructions from suppliers whose components are used with or around the VeriFast™ MicroView controller must be followed accordingly.

Any instructions contained in this manual that directly conflict with any other known safety procedures should be brought to CenterLine's immediate attention for clarification.



- Equipment is not to be modified, adapted, or changed without consulting the relevant sections of this manual or the manufacturer (please refer to the inside front cover of this manual for CenterLine contact information).
 - Before any installation, maintenance, or repair work is started, all sources of energy should be removed from the equipment using proper LOCKOUT procedures for electrical, pneumatic, and water services.
 - Pneumatic and cooling water lines represent potential hazards. Ensure all air and water lines are properly connected and secured prior to turning ON these services.
-



- Batteries represent a potential explosion hazard. Replace batteries only with the specified type.
 - Dispose of used batteries in accordance with applicable instructions and regulations.
-

Handling the VeriFast™ MicroView

In order to prevent potentially serious personal injury, the VeriFast™ MicroView 1.0 should be handled, installed, and operated according to the guidelines outlined in this document. Failure to follow the guidelines set forth here will bear unexpected and potentially dangerous results.

Potential Hazards Related to VeriFast™ MicroView

The VeriFast™ MicroView system has no specific hazards related to it. However, as the VeriFast™ MicroView is used in conjunction with other equipment such as welding equipment and machinery, robot, air supply, etc., the user should be aware of the warnings, hazards, and precautions related to the use of the equipment as a whole.



Lockout Equipment

- Before starting to install the VeriFast™ MicroView components on the welding equipment, ensure that the equipment is disconnected from all sources of power and is in the lockout state.
 - Before turning ON the equipment, make sure all components are assembled properly.
 - Before removing the VeriFast™ MicroView from the welding equipment, make sure the equipment is turned OFF and is in the lockout state.
-

Equipment and Process Overview

Intended Use of Equipment

The VeriFast™ MicroView 1.0 is a stand-alone controller that allows simple integration of analog linear position sensing devices into resistance welding systems that require digital I/O.

The VeriFast™ MicroView 1.0 is available in three configurations:

1. **VeriFast™ MicroView 5-port Dual Device** – can integrate up to two (2) of the following devices:
 - VeriFast™ IA
 - VeriFast™ LPT
 - VeriFast™ LVDT
 - VeriFast™ Laser
 - Generic device that operates on 0 to 10 V
2. **VeriFast™ MicroView 10-port Dual Device** – can integrate up to two (2) of the devices listed above.
3. **VeriFast™ MicroView 5-port Single Device** – can integrate only one VeriFast™ IA or VeriFast™ LVDT. No other devices can be integrated with this configuration.

Regardless of configuration, each device must be connected to a channel on the MicroView controller. For each channel, the user can teach 15 schedules. Every schedule can monitor up to four (4) linear positions, with a set of independent upper/lower tolerance window that can be individually set for each position.

The MicroView can output four (4) digital outputs per channel. These digital outputs are controlled by a nominal position, with tolerances taken into account. When the analog signal is within the window, the corresponding digital output is HIGH.

In addition to the four digital outputs per channel, each channel has a digital output signal indicating if the device has been bypassed (Bypassed is logic HIGH).

The On-board storage has the ability to store up to 500,000 points of data per input device.

Technical Specifications

Table 1 – Technical Specifications of VeriFast™ MicroView 1.0

Parameter	Value
Power:	
Input Voltage / Current	18 VDC – 30 VDC, 1 A max @ 24 VDC
Digital I/O:	
Input	PNP, High True Sourcing $V_{IL} = 2.4$ VDC Max., $I_{IL} = 3.0$ mA Max., $V_{IH} = 30$ VDC Max.
Output	PNP, High True Sourcing $V_{OL} = 0.8$ VDC Max., $I_{OL} = 50$ mA Max., $V_{OH} = 30$ VDC Max.
Environmental:	
Operating Temperature Range	-20°C to 50°C
Enclosure Dimensions (W x H x D)	160 mm x 220 mm x 110 mm (6-5/16 in. x 8-11/16 in. x 4-5/16 in.)

VeriFast™ MicroView Configuration

The three existing configurations of the MicroView controller module are illustrated below, each with corresponding connection cables.

5-port Dual Device Controller and Connection Cables

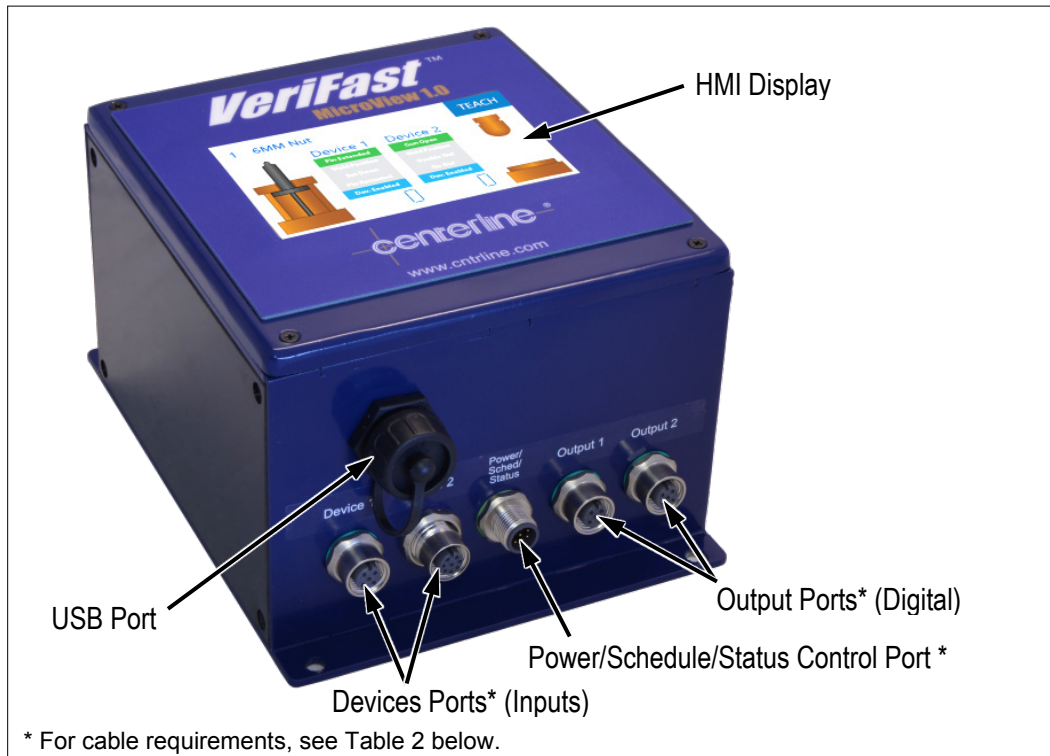

Figure 1 – Configuration of VeriFast™ MicroView 5-port Dual Device Controller

For the cables required to connect the VeriFast™ MicroView 5-port Dual Device Controller, see Table 2 below.

Table 2 – Required connection cables for VeriFast™ MicroView 5-port Dual Device

Type of Cable	Number of Pins	Male/Female	Connection to Port	Number of Cables
M12	5-Pin or 8-Pin **	Male	Device 1, Device 2 (input)	1 or 2
M12	8-Pin	Female	Power/Schedule/Status	1
M12	5-Pin	Male	Output 1, Output 2 (digital)	1 or 2

** Depends on the configuration of the MicroView.

10-port Dual Device Controller and Connection Cables

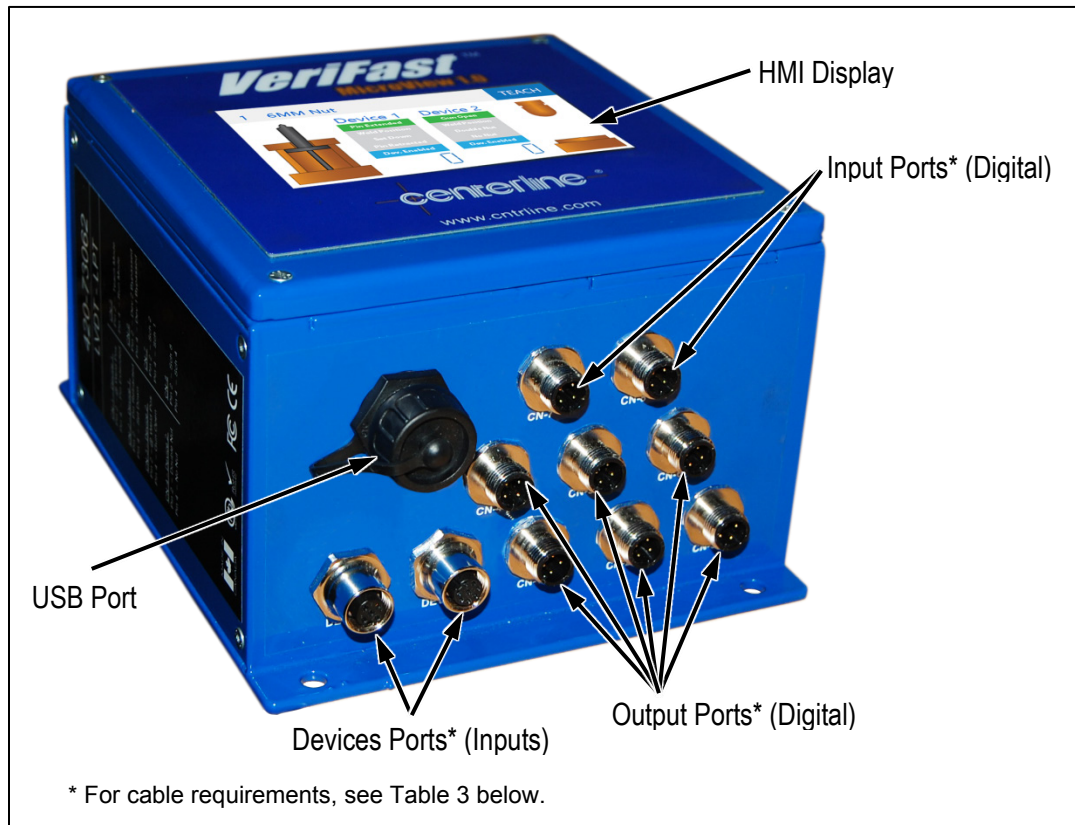

Figure 2 – Configuration of VeriFast™ MicroView 10-port Dual Device Controller

For the cables required to connect the VeriFast™ MicroView 10-port Dual Device Controller, see Table 3 below.

Table 3 – Required connection cables for VeriFast™ MicroView 10-port Dual Device

Type of Cable	Number of Pins	Male/Female	Connection to Port	Number of Cables
M12	5-Pin or 8-Pin **	Male	Device 1 (input), Device 2 (input)	1 or 2
M12	4-Pin	Female	Power, Device 1 P2, Device 1 P1	1
M12	4-Pin	Female	Power, Device 1 P3, Device 1 P4	1
M12	4-Pin	Female	Device 2 P2, Device 2 P1	1
M12	4-Pin	Female	Device 2 P3, Device 2 P4	1
M12	4-Pin	Female	Teach Mode, Run Mode	1
M12	4-Pin	Female	Device 1 Bypass, Device 2 Bypass	1
M12	4-Pin	Female	Schedule 1, Schedule 2	1
M12	4-Pin	Female	Schedule 4, Schedule 8	1

** Depends on the configuration of the MicroView.

5-port Single Device Controller and Connection Cables

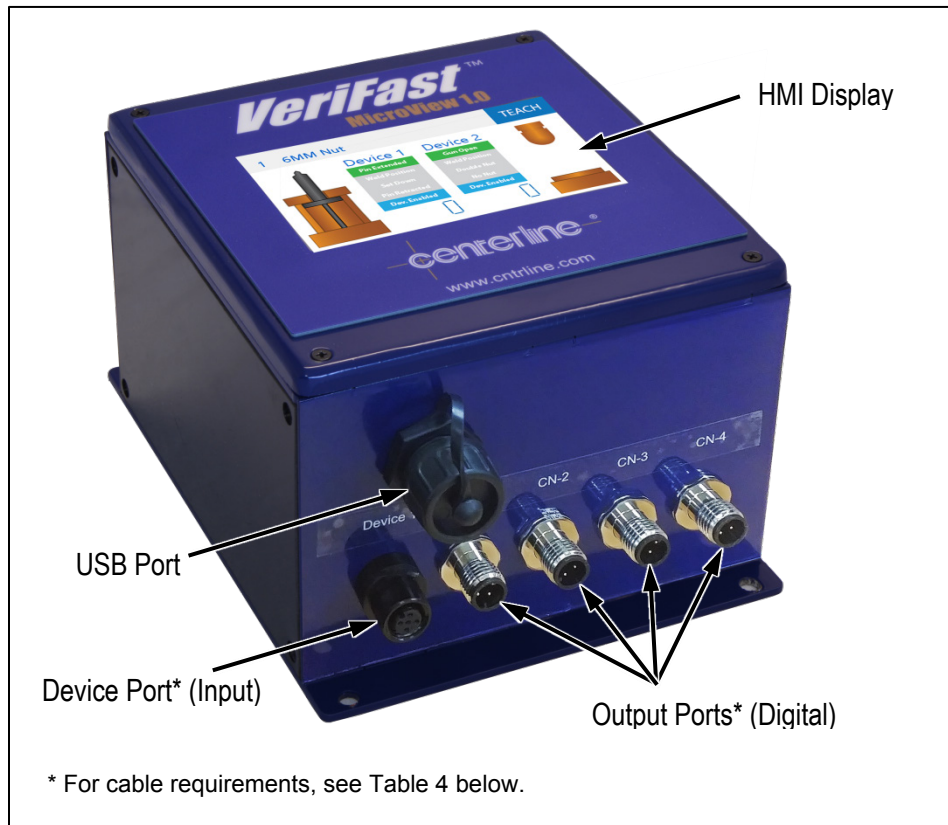

Figure 3 – Configuration of VeriFast™ MicroView 5-port Single Device Controller

For the cables required to connect the VeriFast™ MicroView 5-port Single Device Controller, see Table 4 below.

Table 4 – Required connection cables for VeriFast™ MicroView 5-port Single Device

Type of Cable	Number of Pins	Male/Female	Connection to Port	Number of Cables
M12	5-Pin	Male	Device 1	1
M12	4-Pin	Male	CN-1, CN-2, CN-3, CN-4	4

Description of I/O

Digital Inputs

The VeriFast™ MicroView digital inputs are 30 V tolerant PNP inputs. For a 24 V input, the maximum current drawn will be less than 1 mA.

- Schedule Inputs (4 Bits)
 - a) Binary 1
 - b) Binary 2
 - c) Binary 4
 - d) Binary 8

Table 5 – Minimum Pin Configuration

Number of Schedules Required	Configuration			
	Schedule 1	Schedule 2	Schedule 4	Schedule 8
1	24 VDC	0 VDC	0 VDC	0 VDC
Up to 3	PLC Output	PLC Output	0 VDC	0 VDC
Up to 7	PLC Output	PLC Output	PLC Output	0 VDC
Up to 15	PLC Output	PLC Output	PLC Output	PLC Output

Digital Outputs

The VeriFast™ MicroView digital outputs are PNP outputs and source the voltage present on the V_{IN} to the device. The digital outputs are solid state driven, with a 10 million cycle rating, and a maximum current output rating of 100 mA. If draw exceeds 100 mA, a resettable fuse is triggered. If this happens, it takes approximately 2~5 minutes for the fuse to reset. Each output has independent fuses, so if one is tripped, the others are still active.

1. **Run Enabled** – Logic HIGH when device is in an active run state. Active LOW when device is in maintenance teach state.

Note: This output is not available for 5-port Single Device configurations.

2. **Teach Enabled** – Logic HIGH when device is:

- a) in a maintenance teach mode
- b) in a running teach mode
- c) when teach mode is requested.

Note: This output is not available for 5-port Single Device configurations.

3. **Outputs for both Channel 1 & 2** (**Note:** Position outputs are only active if there is a schedule selected (i.e., schedule inputs not zero) and in Run Mode):

- a) **P1 – Position 1** – Output is HIGH when the analog signal is within the defined tolerance in reference to taught nominal position. That is:
 - i. “Pin Extended” – for VeriFast™ IA, LVDT, or Laser
 - ii. “Gun Open” – for LPT

- b) **P2 – Position 2** – Output is HIGH when the analog signal is within the defined tolerance in reference to taught nominal position. That is:
 - i. “Weld Position” – for VeriFast™ IA, LVDT, or Laser
 - ii. “Weld Position” – for LPT
- c) **P3 – Position 3** – Output is HIGH when the analog signal is within the defined tolerance in reference to taught nominal position. That is:
 - i. “Set Down Achieved” – for VeriFast™ IA, LVDT, or Laser
 - ii. “Double Nuts Present” – for LPT
- d) **P4 – Position 4** – Output is HIGH when the analog signal is within the defined tolerance in reference to taught nominal position. That is:
 - i. “Pin Retracted” – for VeriFast™ IA, LVDT, or Laser
 - ii. “No Nut Present” – for LPT
- e) **Bypassed** – Output is HIGH when the device has been bypassed. **Note:** This output is not available for 5-port Single Device configurations.

Analog Inputs

The two 16-Bit analog inputs are designed for 0-10V operation. These inputs are 30 V tolerant and are wired specifically for the device that is going to be connected to the MicroView. For example, if the input is configured for a VeriFast™ IA or LVDT, only an IA or LVDT (and not an LPT or analog device) can be connected to that input.

For wiring of your particular MicroView, please refer to the information sticker on the side of the MicroView enclosure (an example is shown in Figure 4 below).

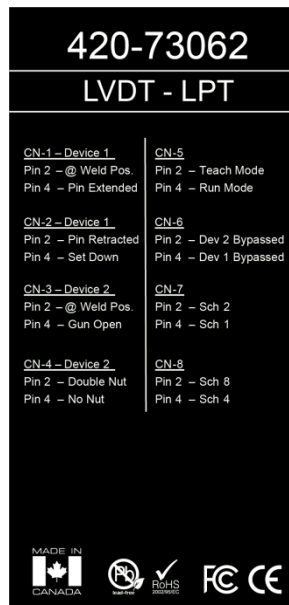

Figure 4 – Example of Information Sticker Affixed to VeriFast™ MicroView

Dimensions of VeriFast™ MicroView Controller

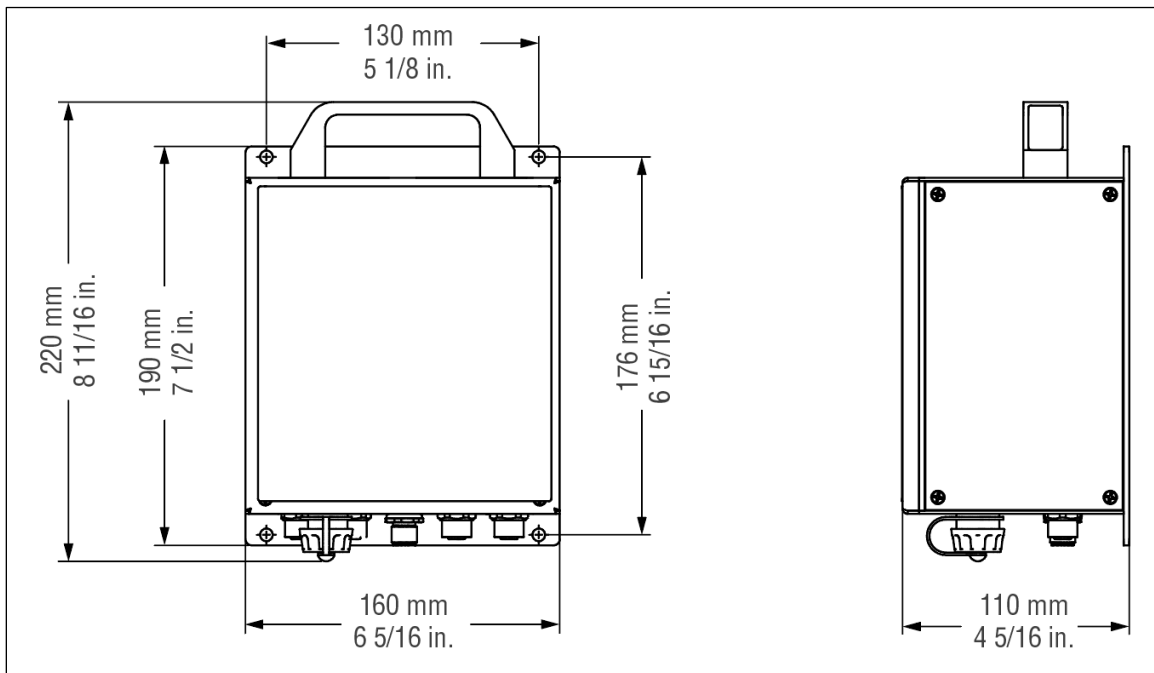

Figure 5 – Dimensions of VeriFast™ MicroView Controller (all configurations)

Part Ordering Information

The MicroView is marked with labels providing information about your specific configuration. When ordering a replacement component, please check your own equipment to find that specific part number. As a reference, see Figure 6 below.

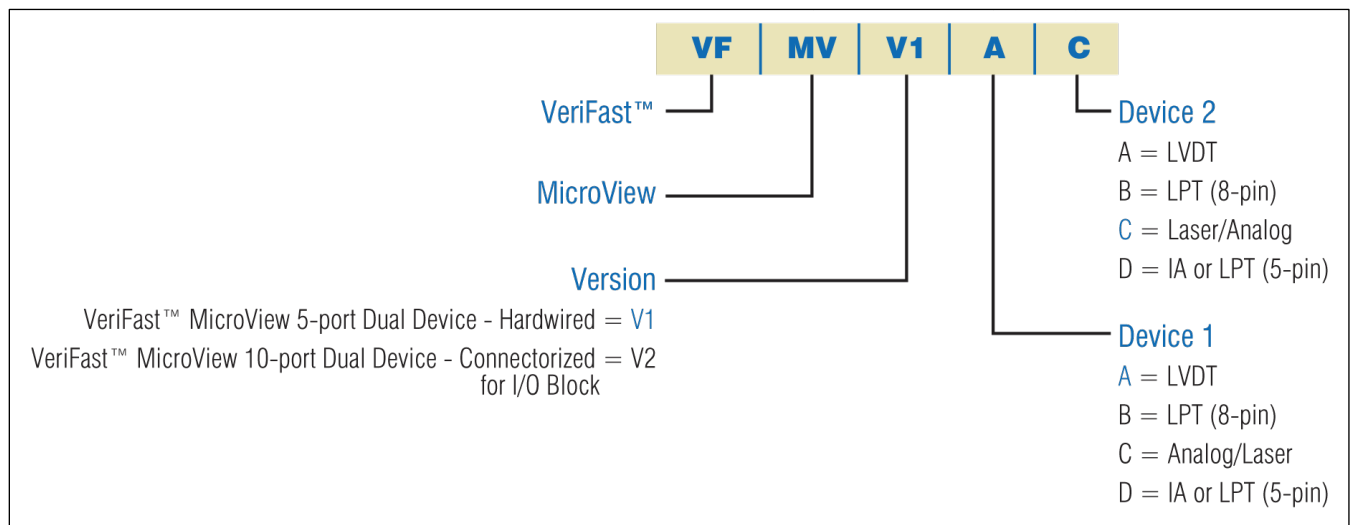

Figure 6 – VeriFast™ MicroView Part Numbering System

Installation Guidelines

Important Safety Information

Please review the *Safety Information* section starting on page 7.



Before installation procedure for the MicroView is started, ensure that all services (e.g., power, air, water) provided to the devices connected to MicroView are de-energized and locked out.

CenterLine recommends that qualified electrical personnel be involved with the setup and operation of the MicroView. Also, a qualified weld engineer or quality control personnel should be available for tolerances adjustments and scaling, when required.

Mounting the MicroView Unit

Using four M4 screws through the mounting holes on the unit's back plate, mount the MicroView on a flat surface in a convenient location on machinery or fixture.

Installation Precaution for Field Block Applications

Prior to connecting a MicroView to a field block, it is recommended to disconnect power on the field block. After the MicroView connections to the field block have been made, it is safe to reconnect power to the field block.

Wiring the Ports of VeriFast™ MicroView

5-port Dual Device Port Configuration

Port on MicroView / Connected Device	Connection	Function
Device 1, Device 2 Ports (Inputs)		
VeriFast™ IA or LPT (5-pin, any brand)	Pin 1	+24 VDC
	Pin 2	0-10 VDC Analog Signal
	Pin 3	0 VDC
	Pin 4	No Connection
	M12 Coupling Nut	Shield
VeriFast™ LVDT	Pin 1	Primary Coil 1
	Pin 2	Primary Coil 2
	Pin 3	Secondary Coil 1
	Pin 4	Secondary Coil 2
	Pin 5	Shield
Analog / Laser	Pin 1	+24 VDC
	Pin 2	No Connection
	Pin 3	0 VDC
	Pin 4	No Connection
	Pin 5	0-10 VDC Analog Signal
Balluff LPT (8-pin)	Pin 1	No Connection
	Pin 2	0 VDC
	Pin 3	No Connection
	Pin 4	No Connection
	Pin 5	0-10 VDC Analog Signal
	Pin 6	Ground (0 VDC)
	Pin 7	+24 VDC
	Pin 8	No Connection
Output 1, Output 2 Ports (Digital Outputs)		
VeriFast™ IA / LVDT / Analog / Laser	Pin 1	P1 – Pin Extended
	Pin 2	P2 – Weld Position
	Pin 3	P3 – Set Down
	Pin 4	P4 – Pin Retracted
	Pin 5	P5 – Bypassed
LPT	Pin 1	P1 – Gun Opened
	Pin 2	P2 – Weld Position
	Pin 3	P3 – Double Nut
	Pin 4	P4 – Nut Missing
	Pin 5	P5 – Bypassed
Power / Schedule / Status Port		
VeriFast™ IA / LVDT / Analog / Laser / LPT	Pin 1	Schedule 1
	Pin 2	+24 VDC
	Pin 3	Status – Run
	Pin 4	Schedule 2
	Pin 5	Schedule 4
	Pin 6	Schedule 8
	Pin 7	0 VDC
	Pin 8	Status – Teach

10-port Dual Device Port Configuration

Port on MicroView / Connected Device	Connection	Function
Device 1, Device 2 Ports (Inputs)		
VeriFast™ IA or LPT (5-pin, any brand)	Pin 1	+24 VDC
	Pin 2	0-10 VDC Analog Signal
	Pin 3	0 VDC
	Pin 4	No Connection
	M12 Coupling Nut	Shield
VeriFast™ LVDT	Pin 1	Primary Coil 1
	Pin 2	Primary Coil 2
	Pin 3	Secondary Coil 1
	Pin 4	Secondary Coil 2
	Pin 5	Shield
Analog / Laser	Pin 1	+24 VDC
	Pin 2	No Connection
	Pin 3	0 VDC
	Pin 4	No Connection
	Pin 5	0-10 VDC Analog Signal
Balluff LPT (8-pin)	Pin 1	No Connection
	Pin 2	0 VDC
	Pin 3	No Connection
	Pin 4	No Connection
	Pin 5	0-10 VDC Analog Signal
	Pin 6	Ground (0 VDC)
	Pin 7	+24 VDC
	Pin 8	No Connection
Output Device Ports and Power / Schedule / Status Port		
CN-1		
VeriFast™ IA / LVDT	Pin 1	+24 VDC
	Pin 2	Device 1, Weld Position
	Pin 3	0 VDC
	Pin 4	Device 1, Pin Extended
Analog / Laser	Pin 1	+24 VDC
	Pin 2	Device 1, P2
	Pin 3	0 VDC
	Pin 4	Device 1, P1
LPT	Pin 1	+24 VDC
	Pin 2	Device 1, Weld Position
	Pin 3	0 VDC
	Pin 4	Device 1, Gun Opened
CN-2		
VeriFast™ IA / LVDT	Pin 1	+24 VDC
	Pin 2	Device 1, Pin Retracted
	Pin 3	0 VDC
	Pin 4	Device 1, Set Down
Analog / Laser	Pin 1	+24 VDC
	Pin 2	Device 1, P4
	Pin 3	0 VDC
	Pin 4	Device 1, P3

Port on MicroView / Connected Device	Connection	Function
LPT	Pin 1	+24 VDC
	Pin 2	Device 1, Double Nut
	Pin 3	0 VDC
	Pin 4	Device 1, No Nut
CN-3		
VeriFast™ IA / LVDT	Pin 1	No Connection
	Pin 2	Device 2, Weld Position
	Pin 3	No Connection
	Pin 4	Device 2, Pin Extended
Analog / Laser	Pin 1	No Connection
	Pin 2	Device 2, P2
	Pin 3	No Connection
	Pin 4	Device 2, P1
LPT	Pin 1	No Connection
	Pin 2	Device 2, Weld Position
	Pin 3	No Connection
	Pin 4	Device 2, Gun Opened
CN-4		
VeriFast™ IA / LVDT	Pin 1	No Connection
	Pin 2	Device 2, Pin Retracted
	Pin 3	No Connection
	Pin 4	Device 2, Set Down
Analog / Laser	Pin 1	No Connection
	Pin 2	Device 2, P4
	Pin 3	No Connection
	Pin 4	Device 2, P3
LPT	Pin 1	No Connection
	Pin 2	Device 2, No Nut
	Pin 3	No Connection
	Pin 4	Device 2, Double Nut
CN-5		
VeriFast™ IA / LVDT / Analog / Laser / LPT	Pin 1	No Connection
	Pin 2	Teach Mode
	Pin 3	No Connection
	Pin 4	Run Mode
CN-6		
VeriFast™ IA / LVDT / Analog / Laser / LPT	Pin 1	No Connection
	Pin 2	Device 2, Bypassed
	Pin 3	No Connection
	Pin 4	Device 1, Bypassed
CN-7		
VeriFast™ IA / LVDT / Analog / Laser / LPT	Pin 1	No Connection
	Pin 2	Schedule 2
	Pin 3	No Connection
	Pin 4	Schedule 1

Port on MicroView / Connected Device	Connection	Function
CN-8		
VeriFast™ IA / LVDT / Analog / Laser / LPT	Pin 1	No Connection
	Pin 2	Schedule 8
	Pin 3	No Connection
	Pin 4	Schedule 4

5-port Single Device Port Configuration

Port on MicroView / Connected Device	Connection	Function
Device 1 Port (Inputs)		
VeriFast™ IA	Pin 1	+24 VDC
	Pin 2	0-10 VDC Analog Signal
	Pin 3	0 VDC
	M12 Coupling Nut	Shield
VeriFast™ LVDT	Pin 1	Primary Coil 1
	Pin 2	Primary Coil 2
	Pin 3	Secondary Coil 1
	Pin 4	Secondary Coil 2
	Pin 5	Shield
Output Device Ports and Power / Schedule Port		
CN-1		
VeriFast™ IA / LVDT	Pin 1	+24 VDC
	Pin 2	P2
	Pin 3	0 VDC
	Pin 4	P1
CN-2		
VeriFast™ IA / LVDT	Pin 1	+24 VDC
	Pin 2	P3
	Pin 3	0 VDC
	Pin 4	P4
CN-3		
VeriFast™ IA / LVDT	Pin 1	No Connection
	Pin 2	Schedule 2
	Pin 3	No Connection
	Pin 4	Schedule 1
CN-4		
VeriFast™ IA / LVDT	Pin 1	No Connection
	Pin 2	Schedule 8
	Pin 3	No Connection
	Pin 4	Schedule 4

Pinout Diagram for 4, 5, and 8 Pin Connectors

Table 6 – Pinout Diagram

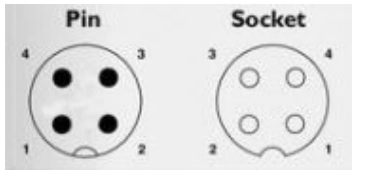
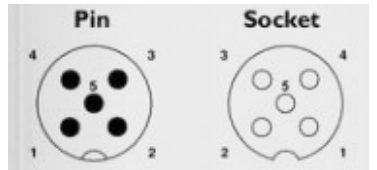
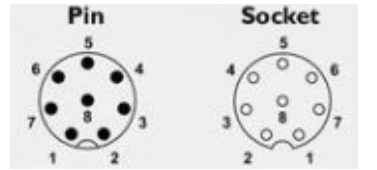
Pin Configuration		
4-Pin	5-Pin	8-Pin
		

Setup Scaling

After the MicroView is mounted and wired, the necessity of performing a setup procedure (called “Scaling”) depends on the type of the measuring unit that will be used during the operation process (i.e., counts, mm, inch):

- **Using Counts during operation** – No setup (scaling) of the MicroView is necessary.
- **Using mm or inch during operation** – Setup (scaling) of the MicroView is required in order for the unit to provide accurate readings during operation.

Scaling must be performed for each new device that is connected to the MicroView. For instructions on how to perform the scaling procedure, refer to the *Scaling Screen* section on page 35. To access the scaling screen, see *Figure 9 – VeriFast™ MicroView Screens* on page 27.

Changing the Default Passwords

When you purchase a new VeriFast™ MicroView system, it is configured with two default passwords to protect menus at different usage levels (user and maintenance level).

IMPORTANT

Changing both passwords during the initial setup of the MicroView system is strongly recommended in order to improve the security and safety of your equipment.

The two **default passwords** are:

- User Password: **12345**
- Maintenance Password: **65500**

The initial passwords provided with the unit can be quickly changed from the *System Settings* screen shown on page 38. For quick access to this screen, navigate through the following screens: *Run -> Teach -> Maint Settings -> More*. Whenever prompted, enter the default passwords provided above. If more detailed instructions are needed, follow the steps provided next.

To change the User and Maintenance Passwords, do the following:

1. While in the *Run Screen* (illustrated on page 28), press the **Teach** button on the top right side of the screen.
2. Enter the User Password when prompted. (For **default** User Password, see bullet above).
3. The *Teach Screen* (illustrated on page 30) displays. At this level of access:
 - The user can teach schedules and positions, as well as name schedules;
 - This screen also gives access to the *Step Thru Teach Screen* (illustrated on page 31).
4. While on the Teach Screen, press the **Maint. Settings** button.
5. Enter the Maintenance Password when prompted. (For **default** maintenance password, see bullet at the top of the page).
6. The *Maintenance Settings Screen* (illustrated on page 33) displays. This screen provides access to menus that allow the following:
 - Change schedules tolerances;
 - Perform scaling;
 - Perform I/O testing;
 - Change operating language;
 - Change measuring units;
 - Set the date and time.
7. While on the *Maintenance Settings Screen*, press the **More** button.
8. The *System Settings Screen (accessible from More button)* screen (illustrated on page 38) displays. This screen provides access to menus that allow the following:
 - Change User and Maintenance Passwords;

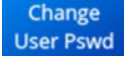
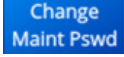
- Enable or disable devices;
 - Access to on board data storage.
9. Press  and  , respectively, to change each password. Enter the new password (twice), as prompted by instructions on the HMI screen. The relevant password will be automatically saved. The next time you are prompted, type in the corresponding new password you just set.

Re-Calibrating the Signal Conditioner (for VeriFast™ LVDT only. This procedure is rarely necessary)

When delivered to the customer, the VeriFast™ LVDT used in connection with the MicroView is fully calibrated for use with a 22 mm weld pin stroke. If a 50 mm weld pin stroke is being used, re-calibration is necessary. Otherwise, **it is highly unlikely that re-calibration is ever necessary.**

Warning: If multiple weld bodies share a common Signal Conditioner (as, for example, on a FlexFast™ welding machine), calibrating the Signal Conditioner using one weld body from one fixture, may affect the function of the other bodies that share the Signal Conditioner. **Be very cautious to re-calibrate!** However, if you decide that the equipment must be recalibrated, follow the instructions below. **Note:** If desired, 22 mm and 50 mm calibration tools that help with the re-calibration process can be purchased from CenterLine.

Calibrating the VeriFast™ LVDT Signal Conditioner consists of entering the Calibration Mode (on the Signal Conditioner) and moving the weld pin to set the extended and retracted positions, which will correspond to the minimum and maximum output voltage. The Signal Conditioner returns to Operating Mode immediately after both positions have been set.

Note: Calibration mode can be cancelled at any time by pressing the buttons 'A' and 'B' (see Figure 8 below) simultaneously for 3 seconds.

In order to re-calibrate the Signal Conditioner, perform the following steps:

1. Access the Signal Conditioner by removing the four screws on the left side cover of the MicroView, as shown in Figure 7 on the right.



Figure 7 – Accessing the Signal Conditioner

2. After system power-up, three (3) minutes of warm up time is recommended.
3. Enter the Calibration Mode by pressing both the 'A' and 'B' buttons (see Figure 8) until the OPER LED will begin blinking (3 seconds minimum).
4. Move the Pin to its **fully extended** position and press the 'B' button. Wait for the Position LEDs to stop blinking.
5. Move the Pin to its **fully retracted** position and press the 'A' button.

If the calibration was successful, the unit will exit the Calibration Mode and operate with its new calibration. The OPER LED will be steady ON. Continue directly with Step 6 below.

If the values after calibration are not as expected, see the following **IMPORTANT** note and ignore Step 6.

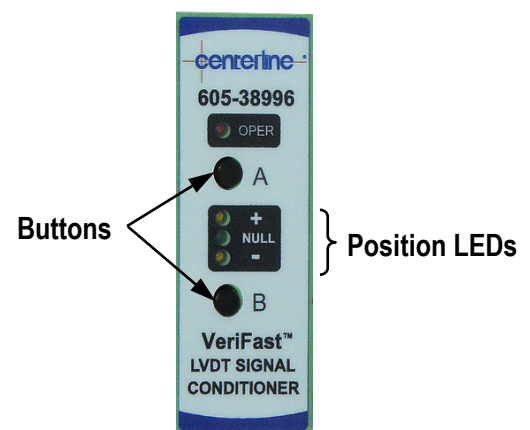

Figure 8 – LVDT Sensor Display and Operating Elements

IMPORTANT

For certain LVDT weld bodies that have geometric variances, following the calibration steps above can repeatedly lead to a failed calibration. In those rare occasions, a slightly modified calibration procedure should be followed, as illustrated in the *Re-Calibrating the Signal Conditioner for Distinct Applications* section.

6. If the calibration process was successful, re-assemble the MicroView by securing the left side cover in its place (see Figure 7 above).

Re-Calibrating the Signal Conditioner for Distinct Applications

The calibration instructions given below may be performed if the values after calibrating the Signal Conditioner as shown in the previous section (*Re-Calibrating the Signal Conditioner* on page 25) are not as expected. At the end of the procedure shown below, the Signal Conditioner will return to Operating Mode immediately after both positions have been set.

Note: Calibration mode can be cancelled at any time by pressing the buttons 'A' and 'B' (see Figure 8 above) simultaneously for 3 seconds.

To calibrate, perform the following steps:

1. Ensure that the left side cover is still removed from the MicroView (see step 1 in the previous section).
2. Ensure that the unit is warmed up for at least three (3) minutes (see step 2 in the previous section).
3. Enter the Calibration Mode by pressing both the 'A' and 'B' buttons (see Figure 8) until the OPER LED will begin blinking (3 seconds minimum).
4. Move the Pin to its fully **retracted** position and press the 'A' button once. Wait for the Position LEDs to stop blinking.
5. Move the Pin to its fully **extended** position and press the 'B' button once. The unit will exit the Calibration Mode automatically and operate with its new calibration. The OPER LED will be steady ON.
6. If the calibration process was successful, re-assemble the MicroView by securing the left side cover in its place (see Figure 7 above).

Software Overview

Screens Navigation Chart

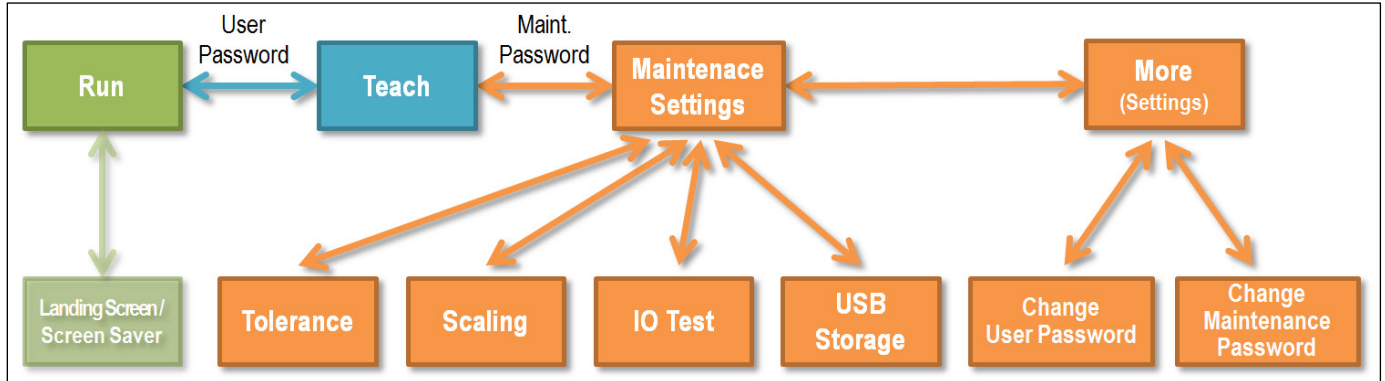

Figure 9 – VeriFast™ MicroView Screens Navigation Chart

Detailed descriptions of each screen follow below.

Landing Screen / Screen Saver

Once the MicroView is plugged in, the HMI will display the landing screen shown in Figure 10. This screen also serves as a screen saver every time the MicroView is in the Run screen (see page 28) and the HMI goes untouched for ten (10) minutes. After an additional five (5) minutes, the screen will turn OFF (black) completely and will remain in that status until the HMI screen is touched again.

To return to the Run screen from the screen saver, touch the HMI screen.

Please note that regardless of the HMI screen's display status, the MicroView unit runs in the background continuously, never shutting down.



Figure 10 – Landing Screen / Screen Saver

Run Screen

The **Run** screen (see Figure 11 below) is the normal operating screen of the MicroView. It is used for monitoring the processes associated with the devices connected to the MicroView. While on this screen, the MicroView is actively scanning the analog inputs at a rate of 800 Hz.

The user can watch the live data for both devices (Device 1 and Device 2) connected to the MicroView. The parameters that are monitored on this screen are listed separately for each device and are in concordance with the type of the device (e.g., Pin Extended, Weld Position, Set Down, and Pin Retracted for VeriFast™ IA and LVDT; Gun Opened, Weld Position, Double Nut, and No Nut for LPT; and so on). The parameters are generally listed as P1, P2, P3, P4 for a generic device.

Note: For VeriFast™ MicroView 5-port Single Device configurations, a VeriFast™ IA or LVDT only will be connected and operational as Device 1. An image and parameters for Device 2 can still be displayed on the screen, but they are not functional.

As an example, Figure 11 below shows a VeriFast™ LVDT (or IA) connected to the MicroView as Device 1, and an LPT connected as Device 2. The instant setting on each list is highlighted: see the green highlighted areas for “Pin Extended” for VeriFast™ LVDT (or IA) and “Weld Position” for the LPT.

A real time animation of the state of both devices is also displayed on this screen.

To further navigate to the Teach Screen (see next sub-section), press the **Teach** button. You will be prompted for the user access password.

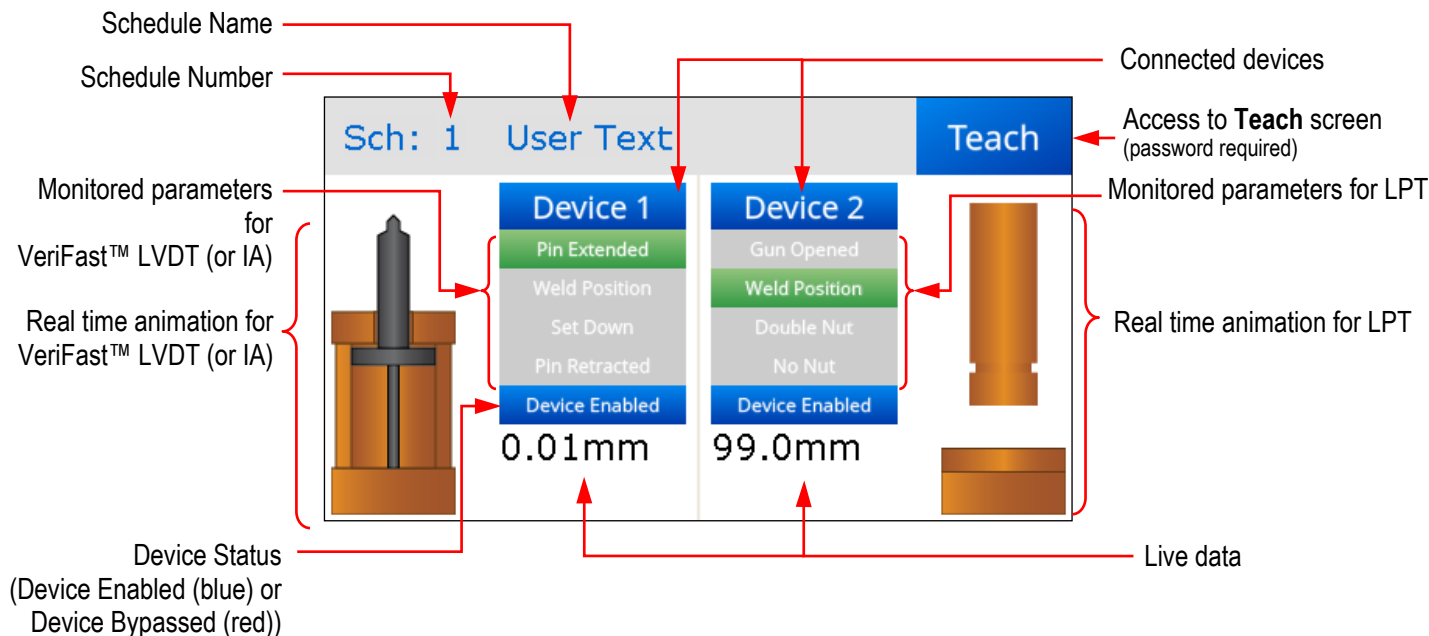

Figure 11 – Run Screen

Password Screen

Two different levels of passwords are used on the MicroView to distinguish users and their access to various levels of menus (see Figure 12 below).

IMPORTANT

The initial passwords provided with the unit can be changed from the System Settings screen shown on page 38 (Run -> Teach -> Maint. Settings -> More).

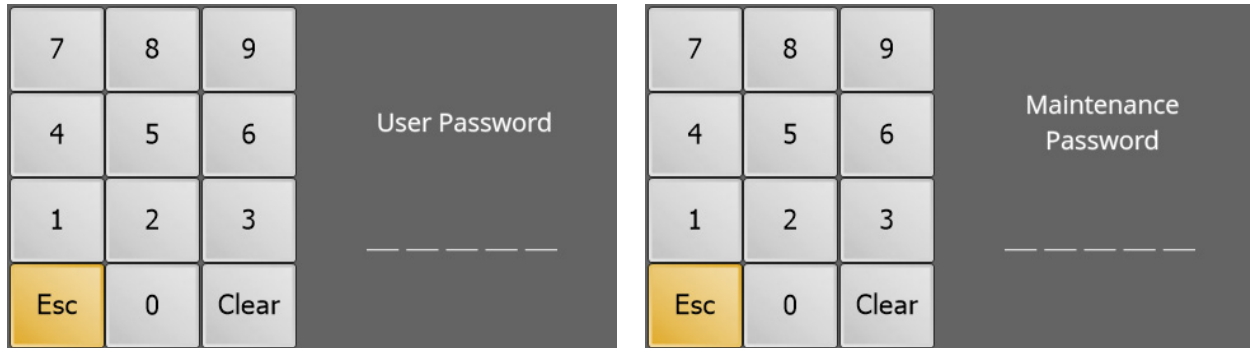

a) User Password Required

b) Maintenance Password Required

Figure 12 – Two Password Levels for MicroView Menus

User Password

The menus protected at the user password level are a limited set of parameters that are useful for day to day operation of the equipment.

Maintenance to welding equipment, pins, or changes in parts can cause the set points to no longer be at the position that had been taught. A user with this level of password is able to re-teach these positions (but not adjust the tolerance).

Maintenance Password

The menus protected at the maintenance password level are for settings which do not need regular changing, or for settings that could cause dramatic changes in operation. Features and parameters such as tolerance, scaling, IO testing, changing passwords, and more can be adjusted and customized at this level.

Teach Screen

The **Teach** screen allows the user to teach the schedules and positions for the devices connected to the MicroView. The access to this screen is protected by the User Password (see *Password Screen* section on page 28 as reference).

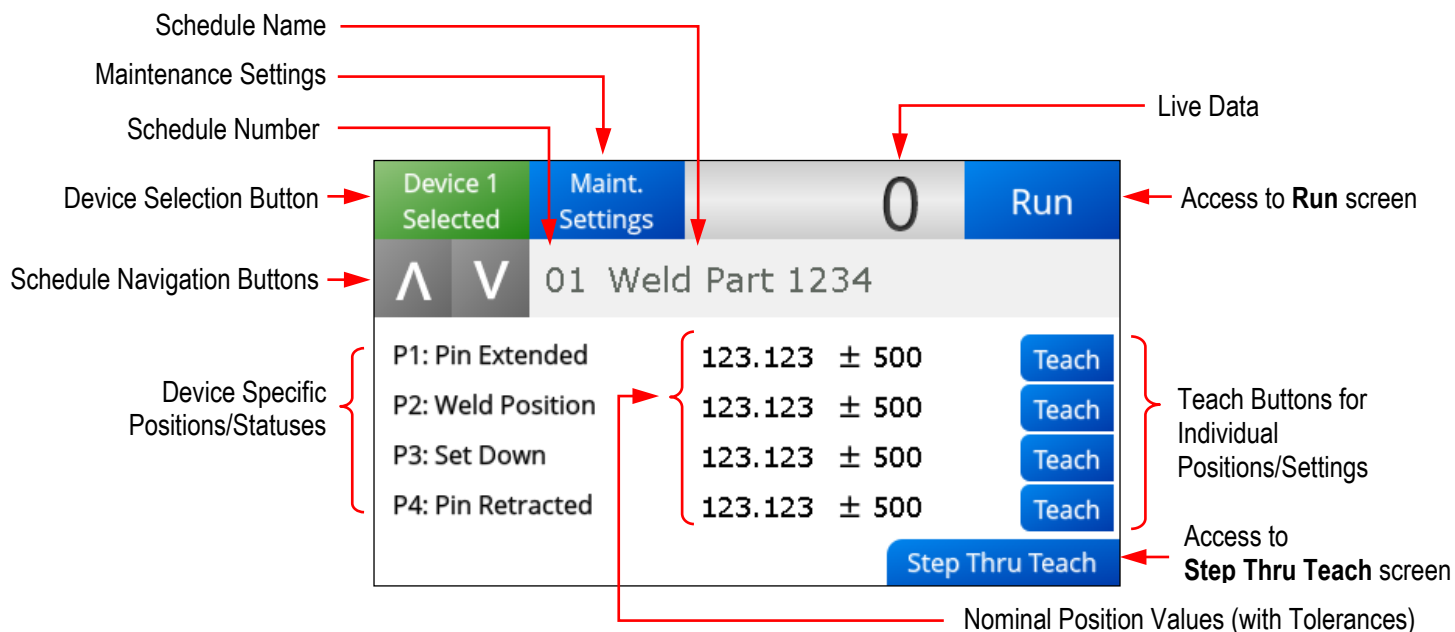

Figure 13 – Teach Screen

The following areas can be identified on the Teach screen (see Figure 13 above):

- Device 1 Selected** – Allows the user to select between the two devices connected to the MicroView, with the intent of teaching schedules for the selected device. In Figure 13 above, for example, Device 1 is a VeriFast™ LVDT (or IA). The user can now select or define a schedule for the current device. Within the current schedule, the user can program the P1, P2, P3, and P4 positions/statuses listed on the screen. See the bullets that follow.
- ^ V** – These navigation buttons allow the user to cycle through a list of schedules defined for the selected device. The name of the current schedule is displayed on the field to the right (see next bullet). Up to 15 schedules can be defined for each of the two devices connected to the MicroView.
- Schedule Number** – Each device connected to the MicroView has 15 schedules assigned to it. A name can also be assigned to each schedule (see the next bullet, Schedule Name). To navigate between the schedules, use the **^ V** buttons on the left.
- Schedule Name** – This field displays the name assigned to the current schedule, if any. If the schedule has not been named, this field will remain empty and the schedule can be identified only by the schedule number (see the bullet above, Schedule Number). Please note that it is not mandatory for the schedule to have a name. A schedule can be renamed at any time by using the **Edit Schedule** button.
- Live Data (Field)** – This field displays the instant value corresponding to the live position of the monitored device. For example, for a VeriFast™ LVDT (or IA) unit connected to the

MicroView as Device 1, this field will indicate the real time position of the weld pin on the VeriFast™ LVDT (or IA) unit.

- **Run** – Press this button to return to the previous screen, *Run Screen* (see page 28).
- **Device Specific Position Statuses (P1, P2, P3, P4)** – The listed parameters/positions (e.g., Pin Extended, Weld Position, etc.) are automatically defined according to the type of the device selected. To learn how to teach each of these parameters/positions, refer to the *Teaching the MicroView* section on page 40.
- **Nominal Position Values** (with Tolerances) – The taught value for each position is displayed in the corresponding field. The tolerances are automatically integrated with these values. Refer to *Teaching the MicroView* section on page 40 for more details.
- **Teach** – Pressing each individual button teaches the position value for each corresponding parameter. Refer to *Teaching the MicroView* section on page 40 for more details.
- **Step Thru Teach** – Pressing this button displays the “*Step Thru Teach*” screen, which is used to teach the current schedule for robot applications only. For details, see the *Step Thru Teach Screen* on page 31.
- **Maint. Settings** – This button transfers the user to the *Maintenance Settings Screen* (accessible by password only) in which the user can define functioning parameters of the system, such as: language, measuring units, tolerances, etc. For more details, see section *Maintenance Settings Screen* on page 33.

Step Thru Teach Screen



Use **extreme caution** while using the Step Thru Teach screen, as all outputs on this screen are live and can generate instantaneous unexpected moves of the robot and attached equipment.

The **Step Thru Teach** screen enables the user to quickly program schedules for robot applications only. The *Step Thru Teach* screen is an extension of the *Teach* screen illustrated in the previous section.

Step Thru Teach is a feature that allows the MicroView to step a robot through the welding procedure while teaching each set point. This feature requires the robot program to be waiting for each position output before proceeding to the next step.

One benefit with this feature is that putting the robot in a teach mode is not necessary. The Step Thru Teach will walk the user through each position, the user will hit the Teach button when the pin is at correct position, and the MicroView will then set that output HIGH. This procedure continues until all four positions (P1, P2, P3, P4) are taught, bringing the user back to the User Setting menu after saving the settings.

To access and teach the parameters/positions for robot applications using the Step Thru Teach Screen, do the following:

1. **Before** using the *Step Thru Teach* Screen, access the *Teach* screen (see *Teach Screen* section on page 30).
2. (While on the Teach screen) **Select the device** (*Device 1* or *Device 2*). Ensure that the desired device remains selected.
3. (While on the Teach screen) **Select, name, and/or rename the desired schedule**. Ensure that the desired schedule remains selected.
4. (While on the Teach screen) **Press the Step Thru Teach button**. The screen below will be displayed.

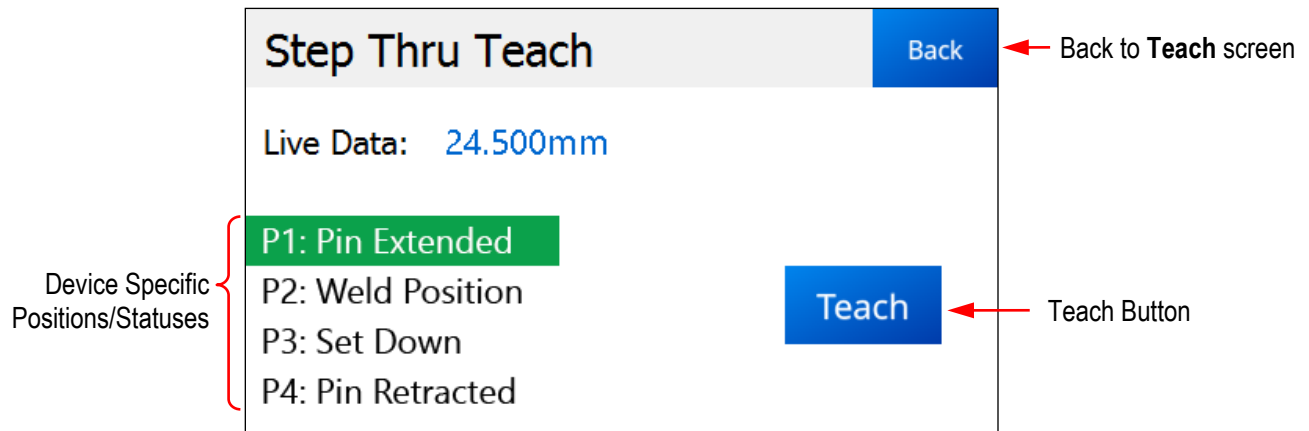

Figure 14 – Step Thru Teach Screen

The following areas can be identified on the Step Thru Teach screen above:

- **Live Data** field displays the instant value corresponding to the live position of the monitored device. For example, for a VeriFast™ LVDT (or IA) unit connected to the MicroView as Device 1, this field will indicate the real time position of the weld pin on the VeriFast™ LVDT (or IA) unit.
 - **Device Specific Positions/Statuses** (e.g., Pin Extended, Weld Position, etc.) are automatically defined according to the type of the device selected. To learn how to teach these parameters/positions, see step 5 below.
 - **Teach** – Press this button to instantly teach (assign) the displayed live data position to the position/status that is currently highlighted green. Once a position/status is taught, the next position/status on the list is automatically highlighted (selected). For more details on how to teach these parameters/positions, see step 5 below.
 - **Back** – Takes the user back to the previous screen (the Teach screen).
5. **Teach the Device Specific Positions/Statuses** according to the *Teaching the MicroView* section on page 40.
 6. **Exit from this screen** by pressing the Back button.

Maintenance Settings Screen

The **Maintenance Settings** screen (shown in Figure 15 below) allows for setting basic function parameters related to the VeriFast™ MicroView 1.0. Access to this screen is protected by the Maintenance Password (see *Password Screen* section on page 28 as a reference).

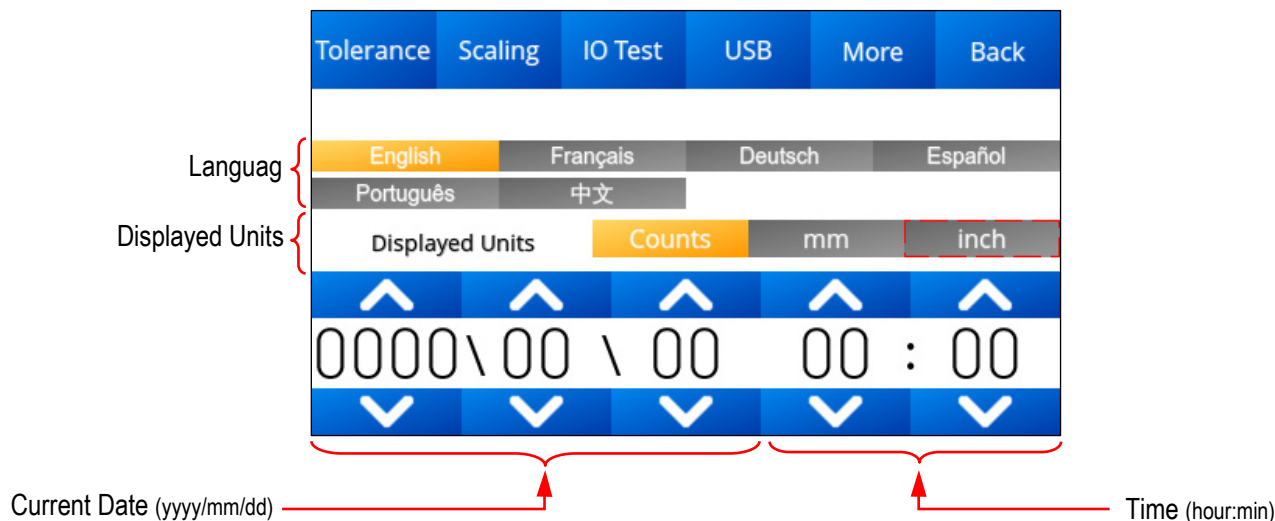

Figure 15 – Maintenance Settings Screen

The following areas can be identified on the Maintenance Settings screen above:

- **Language** – Press to select the desired language as the operating language of the MicroView device.
- **Displayed Units** – Press to select the desired units for measuring during MicroView operation.

IMPORTANT: Ensure that the MicroView has been scaled at the initial setup (see *Scaling Screen* section on page 35). Without proper scaling, the measuring in mm and inches will provide inaccurate readings.



Choosing measurements in **mm** and **in.** require the device to be correctly scaled **before** the start of the process monitoring. While counts measurements still provide accurate readings, using millimeters or inches without initial scaling will lead to erroneous measurements.

- **Current Date** (yyyy/mm/dd) – Use the up and down arrows to set the current date.
- **Time** (hh:mm) – Use the up and down arrows to set the current time.
- **Tolerance** – Press this button to access the *Tolerance* screen. See section *Tolerance Screen* on page 34 for details.
- **Scaling** – Press this button to access the *Scaling* screen. See section *Scaling Screen* on page 35 for details.

- **IO Test** – Press this button to access the *I/O Test screen*. See section *I/O Test Screen* on page 36 for details for details.
- **USB** – Press this button to access the *USB Storage screen*. See section *USB Storage Screen* on page 37 for details.
- **More** – Press this button to access the *System Settings screen*. See section *System Settings Screen (accessible from More button)* on page 38 for details.
- **Back** – Press this button to return to the previous menu.

Tolerance Screen

The **Tolerance** screen in Figure 16 below allows the user to set/adjust the tolerances for each pre-defined position/status (P1, P2, P3, P4). The user needs to ensure that the correct device, schedule, and position/status are selected, and then define the tolerance.

(Note: The *Tolerance* screen is accessible from the *Maintenance Settings Screen* (see page 33)).

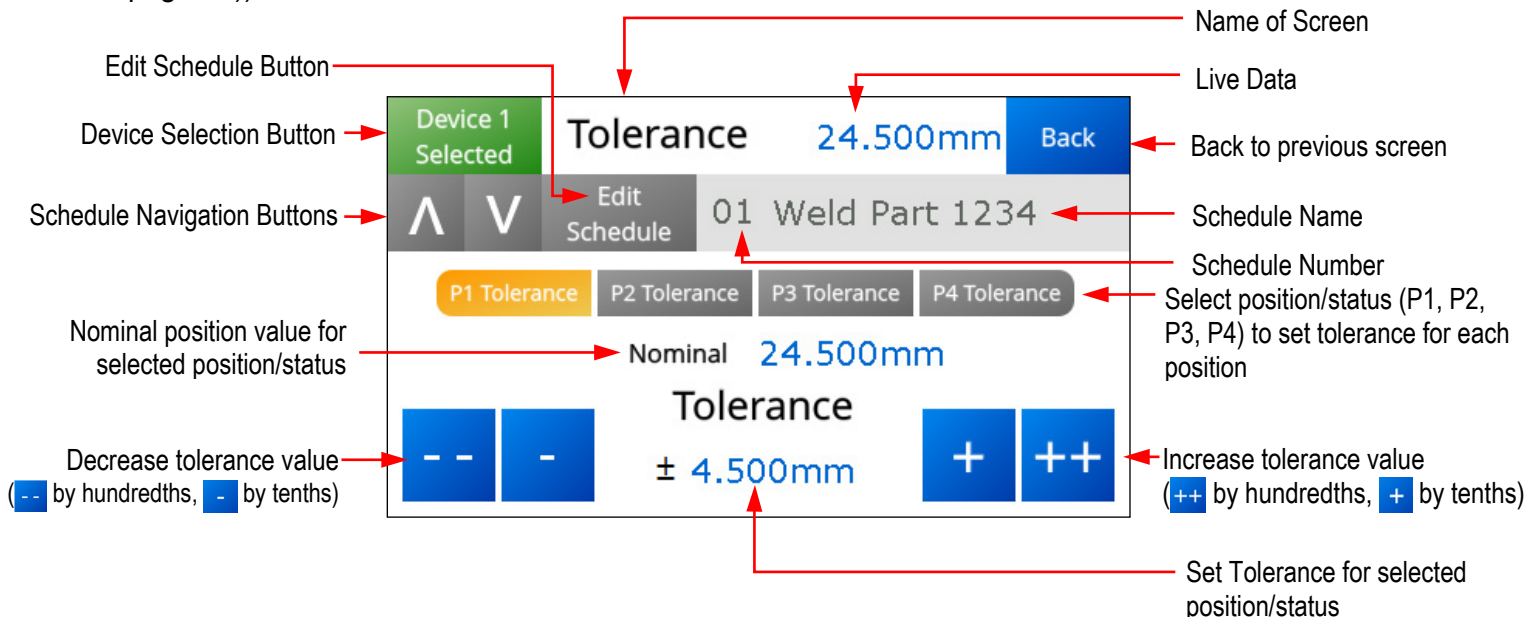

Figure 16 – Tolerance Screen

The following areas can be identified on the Tolerance screen above.

- **Device 1 Selected** – Press this button to choose between the two devices connected to the MicroView. Ensure that the desired device remains selected.
- **^ v** – Use these navigation buttons to navigate through the 15 schedules available for each device connected to the MicroView. Ensure that the desired schedule remains selected.
- **Edit Schedule** – Press this button and a keypad will be displayed, allowing for renaming the selected schedule.

- **Schedule Number** – This field identifies the currently selected schedule number. To navigate through the schedules, use the **^ v** buttons on the left. Ensure that the desired schedule remains selected.
- **Schedule Name** – This field identifies the name of the current schedule (if pre-defined). The user can navigate between the schedules by using the **^ v** buttons on the left. Ensure that the desired schedule remains selected.
- **Live Data** – This field displays the instant value corresponding to the live position of the monitored device. For example, for a VeriFast™ LVDT (or IA) unit connected to the MicroView as Device 1, this field will indicate the real time position of the weld pin on the VeriFast™ LVDT (or IA) unit.
- **P1 Tolerance** **P2 Tolerance** **P3 Tolerance** **P4 Tolerance** – Press the desired button to select (highlight) the position/status for which the tolerances will be established (P1, P2, P3, or P4). Ensure that the desired selection remains highlighted.
- **Nominal** (position value) – This field indicates the already taught value (if any) for the currently selected position/status (P1, P2, P3, or P4). (**Note:** This value corresponds to the *Nominal Position Values* shown in Figure 13 – Teach Screen on page 30).
- **Set Tolerance** – The tolerances for each position/status (P1, P2, P3, or P4) are established (set) on this field. Use the **-- -** and **+ ++** buttons to adjust the values (**--** and **++** by hundredths, **-** and **+** by tenths). For minimum and maximum tolerance intervals that can be set in this field for each type of units, see Table 7 below.

Table 7 – Minimum and Maximum Tolerances for MicroView

Measurement Unit	Minimum Tolerance	Maximum Tolerance
Counts	± 0	± 2000
Millimeters	± 0	± 1.465
Inch	± 0	± 0.058

- **Back** – Press this button to return to the previous menu.

Scaling Screen

The Scaling procedure is used to attune the MicroView unit for accurate measuring in **millimeters (mm) or inches (in.)** during operation. Without proper scaling, measuring in **mm** and **in.** will provide inaccurate readings. Using counts during operation does not require scaling.

The MicroView must be scaled at the initial setup, and subsequently whenever a device is connected to the MicroView unit.

Scaling must be done individually for each device connected to the MicroView using any of the given measuring units (mm or inch).

Note: The Scaling screen is accessible from the *Maintenance Settings Screen* (see page 33).

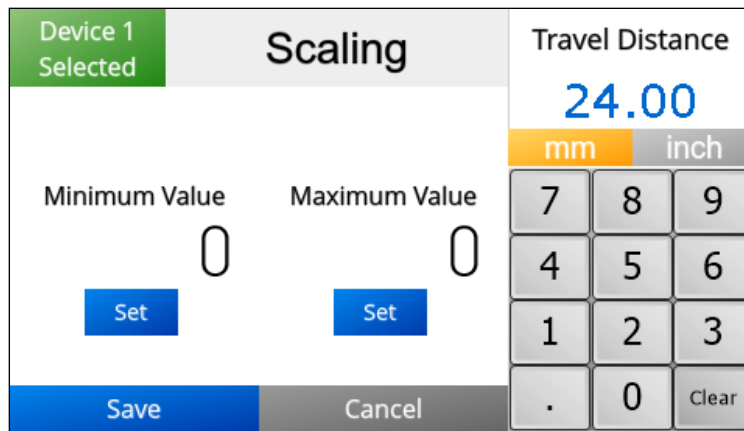

Figure 17 – Scaling Screen

The following areas can be identified in the Scaling screen above.

- **Device 1 Selected** – Press this button to select the device that needs to be scaled. Ensure that the desired device remains selected.
- **Travel Distance** – The number in this field, also called *Sensor Maximum Displacement*, is a pre-defined number, characteristic to each device. The number keypad underneath this field should be used by the user to insert the given travel distance number for the selected device.
- **mm** **inch** – Press the button with the preferred type of measuring unit **for the scaling procedure only**. The button turns yellow when selected. The scaling procedure needs to be performed using one type of measuring units, not both. *Please note that the measuring unit selected on this screen does not affect the choice of measuring units used during the regular operation of the MicroView unit.*
- **Minimum Value** – The value that needs to be recorded in this field corresponds to the minimum travel position of the selected device (e.g., maximum extended position for an LVDT or IA pin, or fully open position for a welding gun (LPT)). To record this value, set the device in the minimum travel position and press the **Set** button underneath.
- **Maximum Value** – The value that needs to be recorded in this field corresponds to the maximum travel position of the selected device (e.g., maximum retracted position for an LVDT or IA pin, or fully closed position for a welding gun (LPT)). To record this value, set the device in the maximum travel position and press the **Set** button underneath.
- **Save** – Press this button to save the settings on the Scaling screen.
- **Cancel** – Press this button to exit the Scaling screen without saving the settings.

I/O Test Screen

This screen is a test screen to check the hardware connection between the MicroView unit and the input device (PLC Input Card or Remote I/O Block).

(Note: The I/O Test screen is accessible from the *Maintenance Settings Screen* (see page 33)).

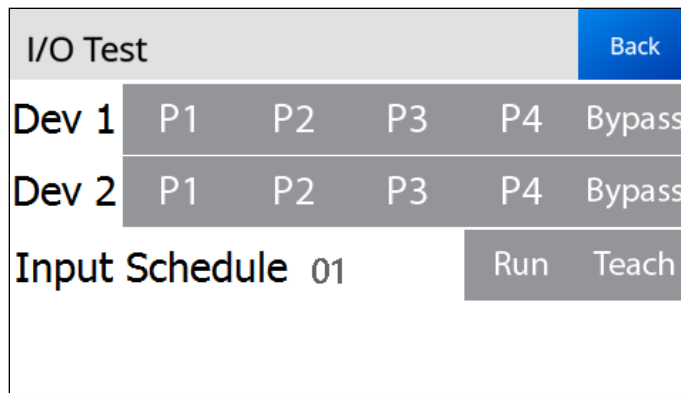

Figure 18 – Input / Output Test Screen

- **P1, P2, P3, P4, Bypass, Run, Teach** – Press on each parameter to verify the proper connection to the PLC. When selected, each button shortly lights up (color coded) on the MicroView screen, and the corresponding LED should light up at the PLC.
- **Input Schedule** – Reflects the current schedule selected from the PLC. This number does not represent the schedule pre-selected in the previous MicroView screens.
- **Back** – Press this button to return to the previous menu.

USB Storage Screen

The MicroView is capable of recording data when the device measures an analog signal that falls within the P2 and P3 nominal positions. This data is recorded internally and then can be downloaded to a USB flash drive.

Note: The USB Storage Screen is accessible from the *Maintenance Settings Screen* (see page 33).

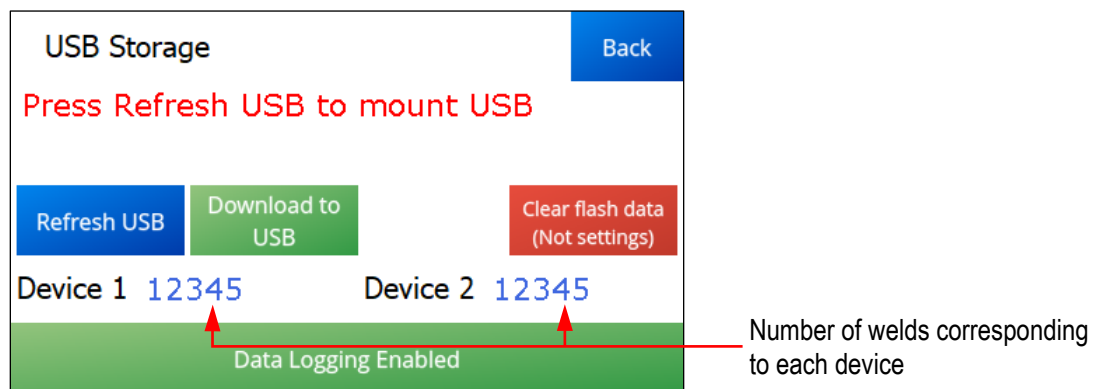

Figure 19 – USB Storage Screen

The following areas can be identified in the USB Storage Screen in Figure 19.

- **Refresh USB** – Press this button to mount an USB Flash drive. If the USB Flash drive is already mounted, pressing this button will try to load the file system again.

- **Download to USB** – Press this button to download all the weld data that is currently stored on the MicroView to the mounted USB Flash drive. The process can take up to 10 minutes if the MicroView storage is full. It will record the data to comma separated files that can be opened in Microsoft Excel or other spreadsheet software.
- **Clear flash data (Not settings)** – Press this button to erase all recorded weld data. This is recommended to be performed after each “Download to USB” procedure (see bullet above), and it may take up to five (5) minutes to execute, as the device has to overwrite all recorded data.
- **Device 1 (and 2) Number** – This field displays the number of welds that have been recorded to the MicroView for the corresponding device.
- **Data Logging Enabled** – This field indicates that the MicroView is enabled for data logging (collection of weld data). Press the button to disable this feature.
- **Back** – Press this button to return to the previous menu.

System Settings Screen (accessible from More button)

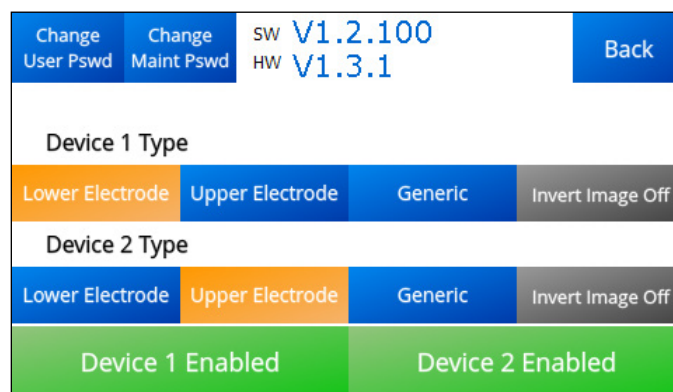





Figure 20 – System Settings Screen

The following areas can be identified in the System Settings Screen in Figure 20.





- **Change User Pswd** – Press this button to set a new User Password (see *User Password* section on page 29).
- **Change Maint Pswd** – Press this button to set a new Maintenance Password (see *Maintenance Password* section on page 29).
- **Lower Electrode**, **Upper Electrode**, **Generic** – Press one of these three buttons available for each device in order to select the component/parameter that needs to be monitored. When a selection is made, the button turns yellow.

IMPORTANT: To verify the selection, go to the *Run Screen* (Figure 11 on page 28) to visualize that the correct component is selected for each device. Depending on the selection, a maximum of two of the graphics and monitored parameters shown in Table 8 can be displayed:

Table 8 – Device Animation and Position Descriptions

Device Representation / Animation Monitored Position / Parameter	Lower Electrode	Upper Electrode	Generic
			
Position 1	Pin Extended	Gun Opened	P1
Position 2	Weld Position	Weld Position	P2
Position 3	Set Down	Double Nut	P3
Position 4	Pin Retracted	No Nut	P4

- Invert Image Off – When OFF (as shown in the image), this button indicates that the device animation is associated from analog input '0' to '32767' (max. position). If pushed, the button will show 'Invert Image On' and the animation direction changes from '32767' (or max. position) to '0'. See table below.

	0	32767
Invert Image Off		
Invert Image On		

- Device 1 Enabled Device 2 Enabled – Press any of these buttons to enable or disable a device. **Note:** Each device connected to the MicroView can be placed in 'BYPASSED' mode, in which the device can be taught, but monitoring on the MicroView screen will be disabled. An input is sent to the PLC to indicate this setting, and a "Device Bypassed" message will be displayed on appropriate MicroView screens.
- Back – Press this button to return to the previous menu.

Teaching the MicroView

Two Teach screens allow the user to teach the schedules for the devices connected to the MicroView:

- **Teach Screen** – for teaching schedules for regular applications (see *Teach Screen* section on page 30).
- **Step Thru Teach Screen** – for teaching schedules for robotic applications only (see *Step Thru Teach Screen* on page 31).

To access these screens, see the *Screens Navigation Chart* on page 27. Remember that both screens are protected by the *User Password* (see page 28).

The principles of learning the MicroView for working with a VeriFast™ IA (Integrated Amplifier), VeriFast™ LVDT (Linear Variable Displacement Transformer), or an LPT (Linear Position Transducer) are similar in both the regular Teach screen, or in the Step Thru Teach screen (for robotic applications only).

To teach any of the positions, place the connected device in the desired position, ensure that the value displayed in the Live Data field is correct, and press the corresponding **Teach** button (situated on the same line with the taught parameter for the standard Teach screen). The taught position will become highlighted green and remain as such until the status of the device will change (e.g., pin will move into a different position). Different positions can be taught for VeriFast™ IA, VeriFast™ LVDT, VeriFast™ Laser, or the LPT, as shown below.

Note 1: Each device connected to MicroView can be placed in ‘BYPASSED’ mode, in which the device can be taught, but monitoring will be disabled. An input is sent to the PLC to indicate this setting, and a “Device Bypassed” message will be displayed on appropriate MicroView screens.

Note 2: During normal consumable wear, after consumables are replaced, and/or after the Signal Conditioner is re-calibrated or replaced (for VeriFast™ LVDT only), some or all VeriFast™ IA, LVDT, and/or gun positions may require re-teaching.

Teaching Positions for VeriFast™ IA, LVDT, or Laser

Table 9 – Teaching Positions for VeriFast™ IA, LVDT, or Laser

Position Taught *	Required Position of IA, LVDT, or Laser Pin and/or status of equipment	How to teach
P1: Pin Extended	Weld pin fully extended	Press the (corresponding) Teach button.
P2: Weld Position	Correct part in place, and Correctly oriented fastener, and Weld gun closed	Press the (corresponding) Teach button.
P3: Set Down	Can be taught only after a successful weld has been achieved, and Weld gun is still closed and intensified	Press the (corresponding) Teach button.
P4: Pin Retracted	Weld pin fully retracted	Press the (corresponding) Teach button.

* Positions can be taught in any order on the *Teach* screen and in circular order on the *Step Thru Teach* screen.

Teaching Positions for LPT

Table 10 – Teaching Positions for LPT

Position Taught *	Required Position of IA, LVDT, or Laser Pin and/or status of equipment	How to teach
P1: Gun Opened	Weld gun fully opened	Press the (corresponding) Teach button.
P2: Weld Position	Correct part in place, and Correctly oriented fastener, and Weld gun closed	Press the (corresponding) Teach button.
P3: Double Nut	<u>TWO</u> fasteners present, and Weld Gun closed	Press the (corresponding) Teach button.
P4: No Nut	No fastener present, and Weld gun closed	Press the (corresponding) Teach button.

* The P1, P2, P3, P4 pin positions can be taught in any order on the standard *Teach* screen (i.e., press to select the desired parameter), and in circular order in the *Step Thru Teach* screen.

Teaching Positions for Generic Device

Four (4) positions (P1, P2, P3, P4) are available to teach any generic device. These positions should be defined by the customer, based on the device specifics and the parameters that need monitoring. To teach any of these positions, press the corresponding **Teach** button. Note that the P1, P2, P3, P4 pin positions can be taught in any order on the standard *Teach* screen (i.e., press to select the desired parameter), and in circular order in the *Step Thru Teach* screen.

Please review the beginning of the *Teaching the MicroView* section on page 40 for more details.

Setting the Tolerance Windows for Fasteners

Due to variances in fastener and stamping manufacturing, it is necessary to consider a range (or “window”) of values that are acceptable for welding rather than just a static point. To determine the proper window that should be used, please refer to the *VeriFast™ LVDT (or IA) User Manual*, section *Setup – Setting the Tolerance Windows for Fasteners*. Input the tolerance windows to the Tolerance Screen of the MicroView (see *Tolerance Screen* section on page 34 of this manual).

Maintenance / Troubleshooting

Important Safety Information

Please review the *Safety Information* section starting on page 7.

IMPORTANT

Follow all plant safety procedures and guidelines, as well as all safety instructions given in this manual before performing any troubleshooting procedures. Only certified personnel should perform any troubleshooting tasks on the machinery.

Servicing the Lithium Battery



CAUTION! Risk of explosion if battery is replaced by an incorrect type. Dispose of used batteries according to the instructions.

The lithium ion battery inside the MicroView is used for maintaining the Real Time Clock inside the data logging circuitry. If the MicroView no longer stores the current Date/Time when power is cycled to the unit, please replace the Lithium Battery for correct operation. The coin cell inside is a Type C1225 Lithium Coin battery.

To replace the battery, do the following:

1. Remove the four M3 flat head Phillips screws from the top of the MicroView enclosure. Pull back the lid so that the MicroView electronics board is visible.



2. Remove the four M3 Phillips pan head screws holding the electronics board to the LCD screen.

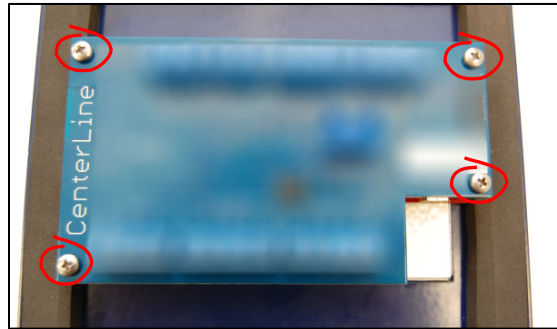

3. Remove the electronics board from the LCD screen.

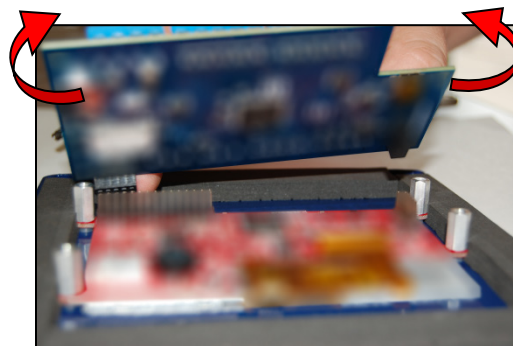

4. Remove the coin battery from the underside of the electronics board.

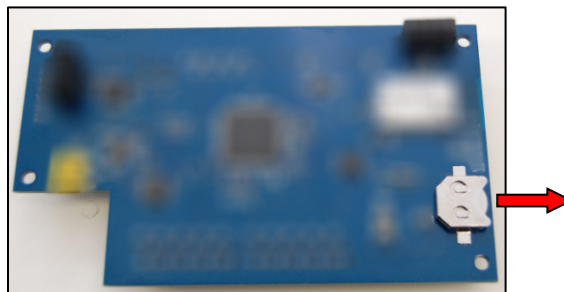

5. Insert the new C1225 coin battery into the holder. Match the positive sign (+) on the battery with the positive sign on the holder.

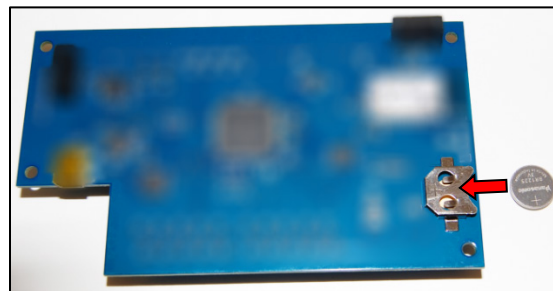

6. Reverse all steps above to re-assemble the MicroView unit.

Resetting Passwords and Settings to Factory Defaults

If you have changed passwords on your MicroView and forgotten the passwords, or you need to reset the unit to factory defaults, follow the instructions below.

1. Unplug the MicroView unit to turn it OFF.
2. Remove the four M3 flat head Phillips screws from the top of the MicroView enclosure.



3. Pull back the lid of the MicroView enclosure so that the electronics board is visible. Switch the following DIP switches, based on what needs to be reset:

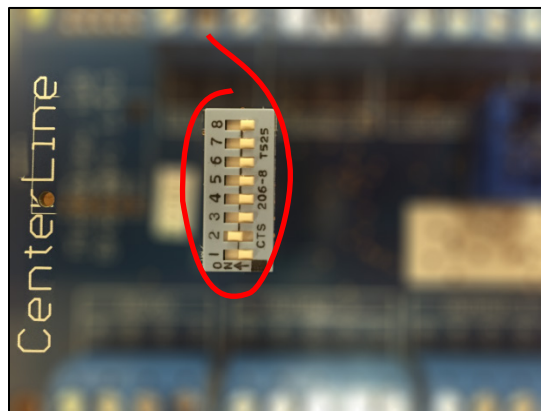

- Reset **User Password**: 6-ON, 7-OFF, 8-OFF
 - Reset **Maintenance Password**: 6-OFF, 7-ON, 8-OFF
 - Reset to **Factory Defaults**: 6-ON, 7-ON, 8-ON
4. Turn the MicroView ON and let it restart.
 5. Once the unit gets to the Run screen, disconnect the power.
 6. Reset switches 6, 7, and 8 to the OFF position.
 7. Re-attach the front cover of the MicroView unit and secure with the four screws.
 8. Plug in the unit to restart.

Troubleshooting Quick Guide



Lockout Equipment

- Before starting to troubleshoot the MicroView, ensure that the equipment is disconnected from all sources of power and is in the lockout state.
- Before turning ON the equipment, make sure all components are assembled properly.

Table 11 – Troubleshooting the VeriFast™ MicroView 1.0

Problem	Hint	Suggestion
MicroView not running	Is the MicroView unit connected / wired properly?	Check the power source for correct voltage (see <i>Technical Specifications</i> section on page 9).
		Check the power connection on the Power / Schedule / Status Port and ensure the device has power.
	Is the MicroView unit in Teach Mode?	Ensure the MicroView unit is either on the Run page or has gone into screensaver mode for proper operation. When the unit is on a Teach page, the device outputs are disabled.
Output pins not turning ON	No schedule selected	When there is no selected schedule, the MicroView will not operate. Ensure that the Schedule pins are wired such that the binary value is between 1 and 16.
	Channel Bypassed	If a channel is bypassed, the MicroView will not operate the schedule on that channel, and no outputs will turn ON for that Output Port, except the Bypass signal.
	Is the MicroView unit in Teach Mode?	Ensure the MicroView unit is either on the Run page, or has gone into screensaver mode for proper operation. When the unit is on a Teach page, the device outputs are disabled.
	Consumable worn / changed	Re-teach positions as necessary.
Erroneous distance reading (e.g., moving the sensor 1 mm and device indicating 2 mm)	Improper setup scaling.	MicroView requires proper scaling for each device connected to it. For proper scaling instructions, see <i>Scaling Screen</i> section on page 35.
Password not working	Incorrect password	Reset MicroView unit to factory default password. See section <i>Resetting Passwords and Settings to Factory Defaults</i> on page 44.

Decommissioning

Preparing for Storage

The following guidelines should be followed when removing a MicroView from service:

- Disconnect the MicroView system from all external supplies (i.e., electrical) and connected devices. Identify the connections to facilitate a future installation.
- The storage location must be clean, dry, and not expose the MicroView system to mechanical or thermal damage. If the MicroView will be covered, there should be some air circulation to prevent condensation.

Index

1

- 10-port Dual Device
 - Port Configuration, 18
 - Wiring the Ports, 18

5

- 5-port Dual Device
 - Cables, 10
 - Controller Configuration, 10
 - Port Configuration, 17
 - Wiring the Ports, 17
- 5-port Single Device
 - Cables, 12
 - Controller Configuration, 12
 - Port Configuration, 20
 - Wiring the Ports, 20

A

- Analog Input, 14

B

- Battery, 42
 - Servicing the, 42
 - Type, 42

C

- Calibrating
 - Re-Calibrating the Signal Conditioner, 25
 - Re-Calibrating the Signal Conditioner for Distinct Applications, 26
- Channel
 - Digital Output, 13
- Configuration
 - 5-port Dual Device Controller, 10
 - 5-port Single Device Controller, 12

- of Pins, 21
- VeriFast™ MicroView, 10

- Connection Cables
 - for 5-port Dual Device Controller, 10
 - for 5-port Single Device Controller, 12

D

- Decommissioning, 46
- Digital Input, 13
 - Configuration, 13
 - Number of Schedules, 13
 - Pin Configuration, 13
- Digital Output, 13
 - for Channels, 13
 - Run Enabled, 13
 - Teach Enabled, 13
- Dimensions of VeriFast™ MicroView, 15

F

- Factory Defaults, 44
- Fastener
 - Setting the Tolerance Windows, 41

H

- Hazards
 - Potential Hazards, 7

I

- I/O
 - Description, 13
 - Test Screen, 36
- Input
 - Analog, 14
 - Digital, 13
 - Schedule, 13

Installation, 16
 Mounting the MicroView Unit, 16
Instructions
 Safety, 7

L

Label
 Wiring of MicroView, 14
Landing Screen, 27

M

Maintenance, 42
 Password, 29
 Settings Screen, 33
Maintenance Password
 Change the, 23
 Reset, 44
 Screen, 28
MicroView. See VeriFast™ MicroView
 Wiring Label, 14
Mounting the MicroView Unit, 16

O

Output
 Digital, 13
 for Channels, 13
 Run Enabled, 13
 Teach Enabled, 13

P

Part Ordering Information, 15
Password
 Change Maintenance Password, 23
 Change User Password, 23
 Maintenance, 28
 Maintenance Password, 29
 Reset the, 44
 Screen, 28
 User, 28

User Password, 29

Pin
 Configuration, 21
Pinout Diagram, 21
Ports
 Wiring the 10-port Dual Device, 18
 Wiring the 5-port Dual Device, 17, 20
Process Overview, 9

R

Re-Calibrating
 the Signal Conditioner, 25
 the Signal Conditioner for Distinct Applications, 26
Run
 Enabled Digital Output, 13
 Screen, 28

S

Safety
 Information, 7
 Potential Hazards, 7
Scaling
 Screen, 35
 Setup, 22
Schedule
 Inputs, 13
Screen Navigation
 Chart, 27
 I/O Test, 36
 Landing Screen, 27
 Maintenance Password, 29
 Maintenance Settings Screen, 33
 Password Screen, 28
 Run Screen, 28
 Scaling Screen, 35
 Screen Saver, 27
 Step Thru Teach Screen, 31
 System Settings, 38
 Teach Screen, 30
 Tolerance Screen, 34

- USB Storage Screen, 37
- User Password, 29
- Setting the Tolerance Windows for Fasteners, 41
- Setup
 - Scaling, 22
- Signal Conditioner
 - Re-Calibrating, 25
 - Re-Calibrating for Distinct Applications, 26
- Software Overview, 27
 - Screen Navigation Chart, 27
- Specifications
 - Technical Specifications, 9
- Step Thru Teach Screen, 31
- Storage
 - Preparing for Storage, 46
- System Settings Screen, 38

T

- Teach
 - Enabled Digital Output, 13
 - Positions for Generic Device, 41
 - Positions for VeriFast™ IA, 40
 - Positions for VeriFast™ Laser, 40
 - Positions for VeriFast™ LPT, 41
 - Positions for VeriFast™ LVDT, 40
 - Screen, 30
 - Step Thru Teach Screen, 31
 - Teach Screen, 31
 - the MicroView, 40
- Technical Specifications, 9
- Tolerance
 - Setting the Tolerance Windows, 41
- Tolerance Screen, 34
- Troubleshooting, 42
 - Quick Guide, 45

U

- USB Storage Screen, 37
- User Password, 29
 - Change the, 23
 - Reset, 44
 - Screen, 28

V

- VeriFast™ MicroView
 - Analog Inputs, 14
 - Battery Servicing, 42
 - Configuration, 10
 - Description of I/O, 13
 - Digital Inputs, 13
 - Digital Outputs, 13
 - Dimensions, 15
 - I/O Description, 13
 - Intended Use, 9
 - Maintenance, 42
 - Mounting, 16
 - Overview, 9
 - Part Ordering Information, 15
 - Reset Passwords, 44
 - Reset to Factory Defaults, 44
 - Screen Navigation, 27
 - Software Overview, 27
 - Teaching Positions, 40
 - Teaching the, 40
 - Technical Specifications, 9
 - Troubleshooting, 42
 - Wiring the Ports, 17

W

- Wiring
 - the Ports of 10-port Dual Device, 18
 - the Ports of 5-port Dual Device, 17
 - the Ports of 5-port Single Device, 20